

FRONT VIEW

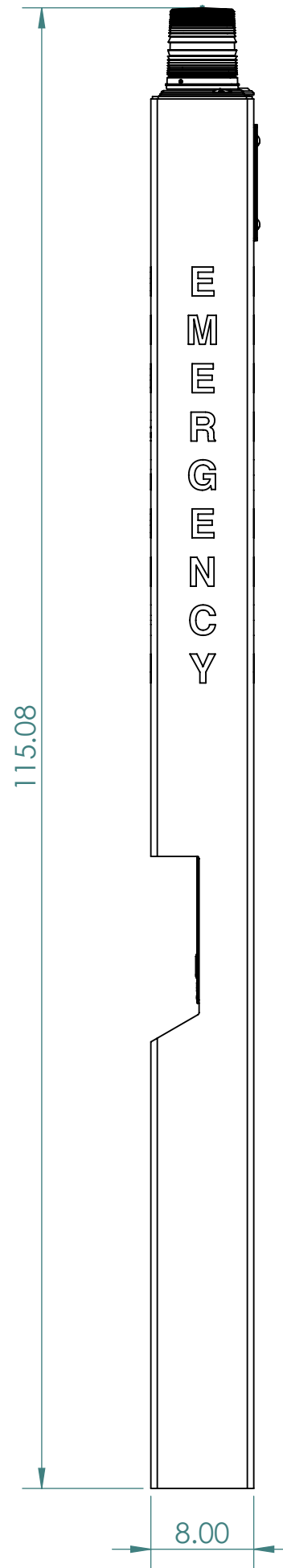

SIDE VIEW

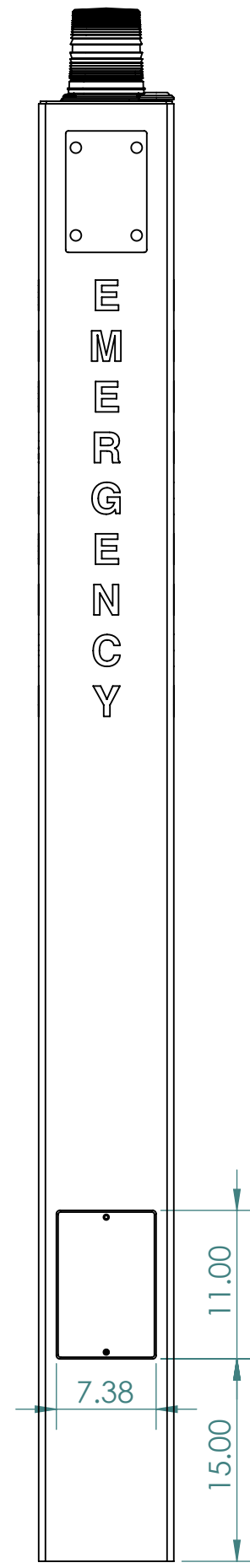

REAR VIEW

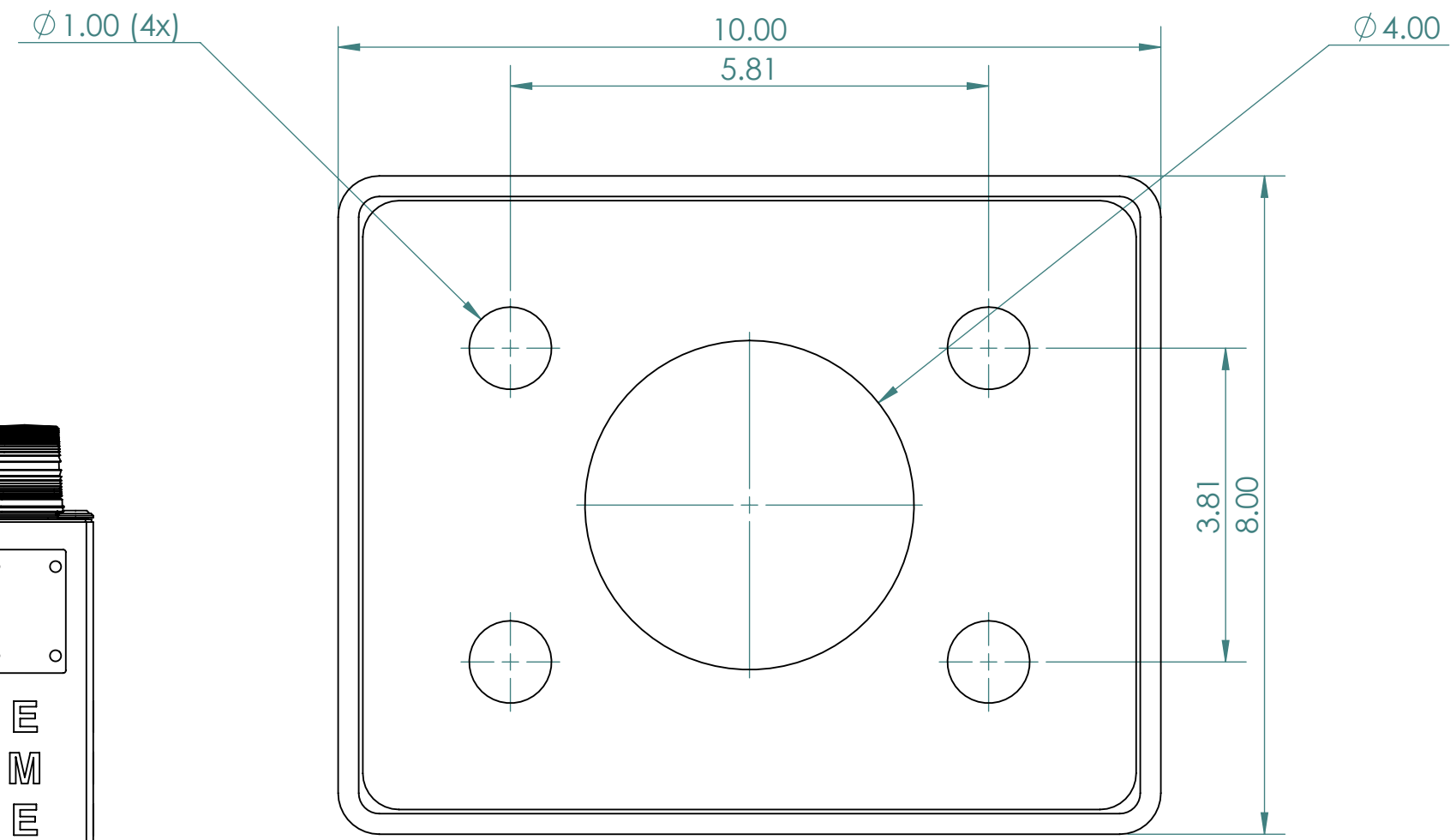

FOOT PRINT

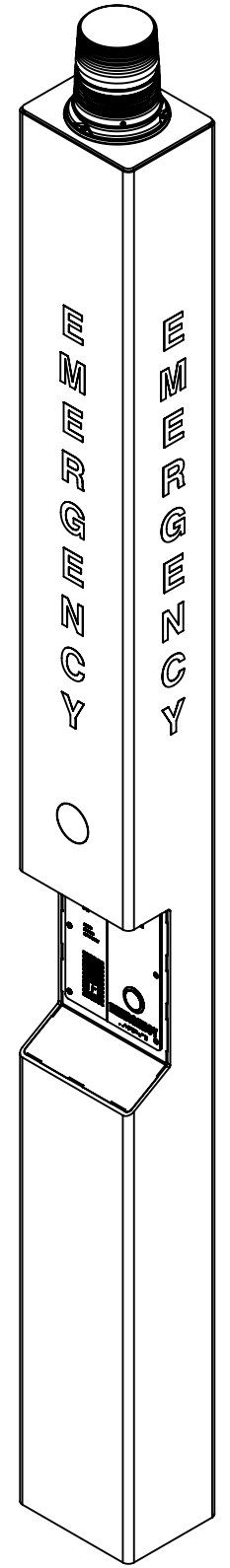

ISOMETRIC VIEW

OP2: CAMERA CUTOUT
[CAMERA NOT PROVIDED
BY TALKAPHONE]

CALL STATION MODEL:
VOIP-600E [SHOWN
FOR ILLUSTRATION ONLY]

FINISH

PROPRIETARY AND CONFIDENTIAL
THE INFORMATION CONTAINED IN THIS
DRAWING IS THE SOLE PROPERTY OF
TALK-A-PHONE, LLC. ANY
REPRODUCTION IN PART OR AS A WHOLE
WITHOUT THE WRITTEN PERMISSION OF
TALK-A-PHONE, LLC IS PROHIBITED.

1.0	MARKETING RELEASE	06/18/2020	J MAHETALIA
REV.	DESCRIPTION	DATE	APPROVED
REVISIONS			
	NAME	DATE	
DRAWN	J MAHETALIA	06/18/2020	
CHECKED	K PATEL	06/18/2020	
ENG APPR.			
MFG APPR.			
Q.A.			
COMMENTS:			
 TALKAPHONE TALK-A-PHONE, LLC 7530 N. NATCHEZ AVE. NILES, IL 60714 WWW.TALKAPHONE.COM		DWG. NO. SIZE PART NO. ETP-MTE-OP2 REV C DWG. TITLE: ETP-MT SERIES 1.0 SCALE: 1:12 WEIGHT: SHEET 1 OF 2	

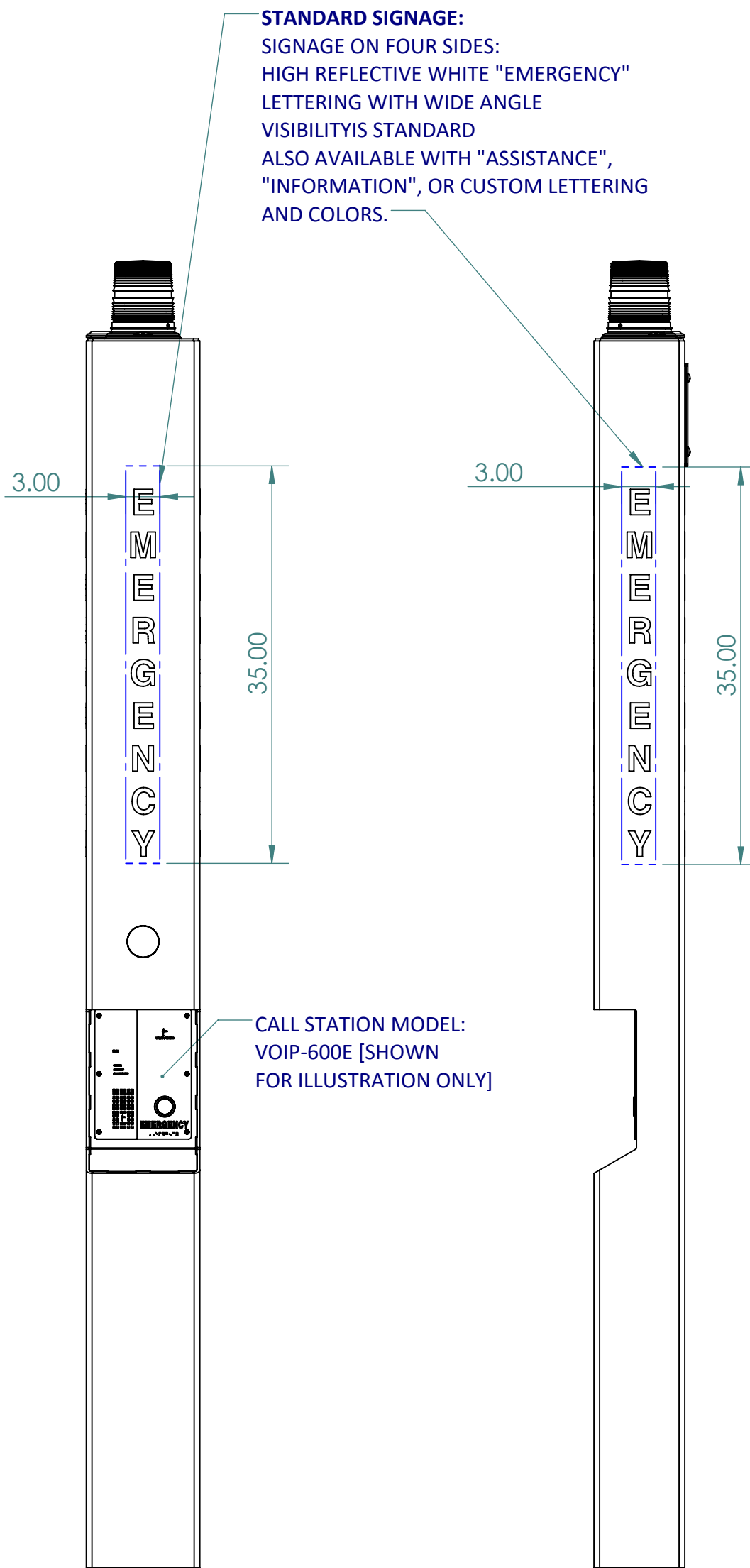

FRONT VIEW

STANDARD SIGNAGE:
SIGNAGE ON FOUR SIDES:
HIGH REFLECTIVE WHITE "EMERGENCY"
LETTERING WITH WIDE ANGLE
VISIBILITY IS STANDARD
ALSO AVAILABLE WITH "ASSISTANCE",
"INFORMATION", OR CUSTOM LETTERING
AND COLORS.

CALL STATION MODEL:
VOIP-600E [SHOWN
FOR ILLUSTRATION ONLY]

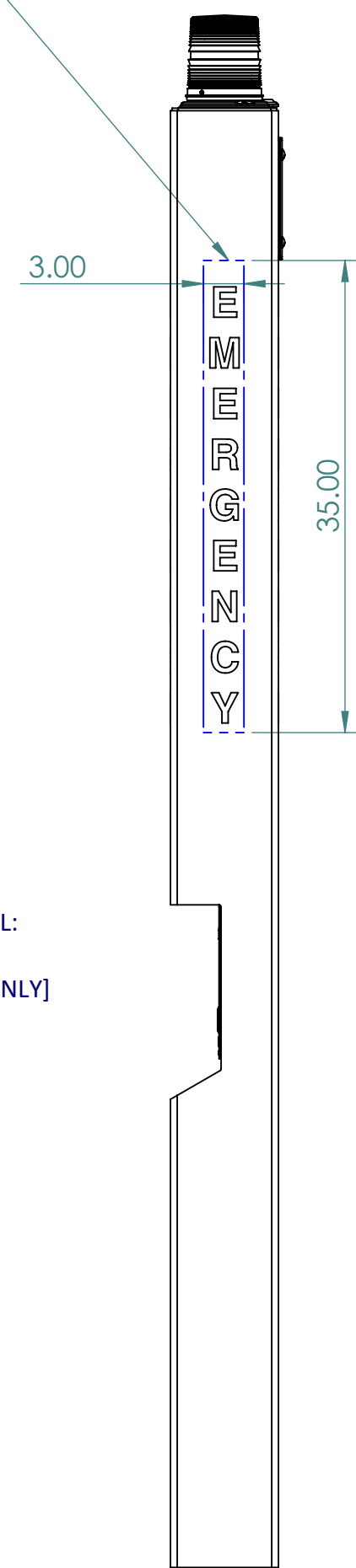

SIDE VIEW

STANDARD FINISH:
PAINTED IN SAFETY BLUE COLOR
OPTIONAL FINISH:
AVAILABLE PAINTED IN CUSTOM COLORS

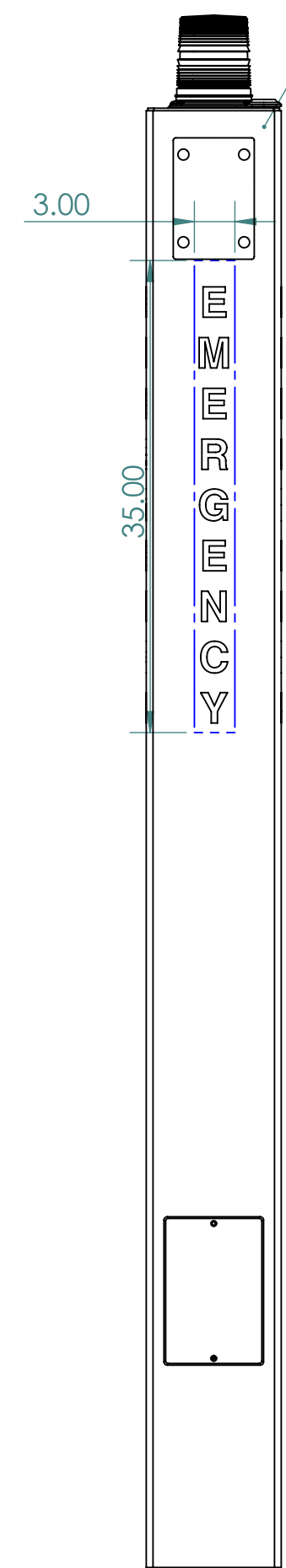

REAR VIEW

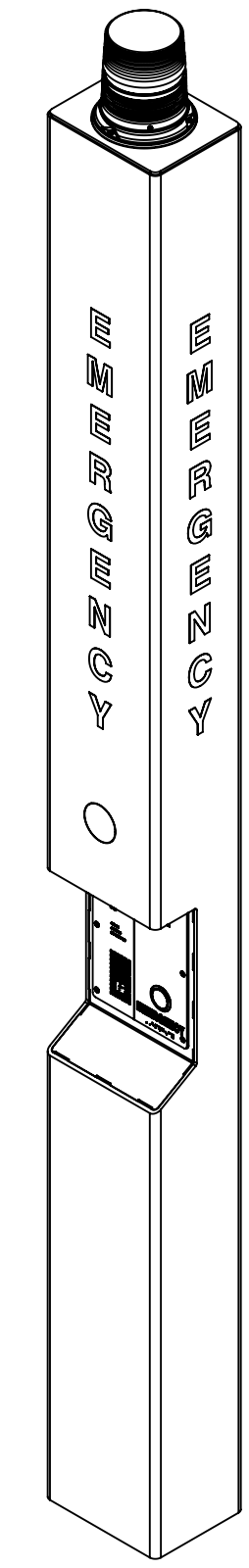

ISOMETRIC VIEW

FINISH
PROPRIETARY AND CONFIDENTIAL
THE INFORMATION CONTAINED IN THIS
DRAWING IS THE SOLE PROPERTY OF
TALK-A-PHONE, LLC. ANY
REPRODUCTION IN PART OR AS A WHOLE
WITHOUT THE WRITTEN PERMISSION OF
TALK-A-PHONE, LLC IS PROHIBITED.

	NAME	DATE
DRAWN	J MAHETALIA	06/18/2020
CHECKED	K PATEL	06/18/2020
ENG APPR.		
MFG APPR.		
Q.A.		

TALKAPHONE
TALK-A-PHONE, LLC
7530 N. NATCHEZ AVE. NILES, IL 60714
WWW.TALKAPHONE.COM

DWG. NO.	SIZE	PART NO.	ETP-MTE-OP2	REV	1.0
	C	DWG. TITLE:	ETP-MT SERIES		
	SCALE: 1:12	WEIGHT:		SHEET 2 OF 2	